

**Operation Manual for Jacketed Temperature-control
Liposome Extruder**

Catalog No. Gextruder-10ml; Gextruder-100ml;
Gextruder-800ml; Gextruder-3000ml; Gextruder-10000ml





Instruction Manual

High-pressure Jacketed Extruder

1. Open-box Inspection

Check whether there is any packing damage. Refer to the shipping list for the integrity of the product.

2. Product Introduction

2.1 Brief Introduction

Genizer™ jacketed temperature-control liposome extruder is made of pharmaceutical grade 316L stainless steel approved by FDA and GMP, finished by laser boring on stainless steel micron-pore supporting plate, which can guarantee the maximum pressure resistance of filter membrane. The main application of extruder is nanoparticulation and homogenization of pharmaceutical liposome and emulsion. The extruder prepares liposomes and emulsions with 50-400 nm track-etched membrane. The extruder supports Handgenizer™ and other high pressure homogenizers, therefore allows the simultaneous operation of high pressure homogenizing and filters extruding. With the jacketed temperature-control design, the equipment is able to heat or cool materials, therefore applicable to the high-viscosity products.

2.2 Specifications

Maximum pressure	100 bar
Finished product size	50-500 nm
Maximum concentration	200 mg/ml
Operation capacity	10-10,000 ml
Operating temperature	0-100°C
Product material	316L stainless steel
Working condition	High-pressure gas or high-pressure pump
Material standard	Pharmaceutical grade

3. Safety Instruction



Attention: The designed maximum pressure is 1,500 psi.

Please do not exceed this pressure during operation.





Warning: Don't operate the extruder unless there is a sufficient number of pull rods. Check the wear of the pull rod routinely and replace it when necessary.



Danger: Check the O-rings routinely and replace them when necessary. Damaged or worn O-rings may break suddenly and cause a sudden decompression of the extruder. Fracture of O-rings may also lead to high-speed discharge of liquid materials.

 **Warning:** The jacket of the extruder may be overheated in operation and cause burns. Please be careful.

 **Warning:** Lift and move the extruder carefully to avoid crush injuries.

 **Warning:** Genizer™ high-pressure extruder should be operated in according to related safety requirements. Operators must wear protective clothing and operate the extruder in hood or shelter. Any personnel or property loss due to any violation of safety requirements should be assumed by the organization or individual using it.



 **Warning:** Using original parts to replace worn or damaged parts. Replacement with non-original parts will not be warranted.

4. Parts List

Regular parts of Genizer™ jacketed temperature-control extruder are listed below:

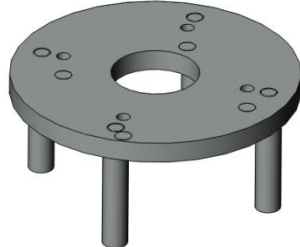
Part No.	Part Name	Quantity
1	Bracket base	1

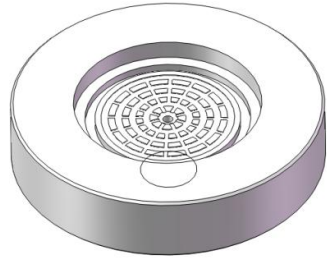
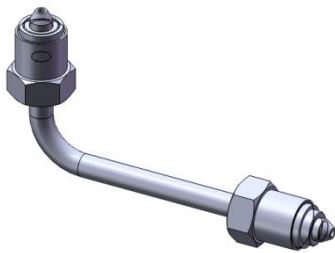
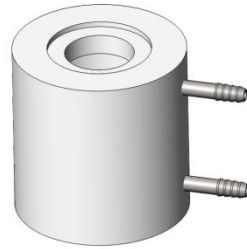

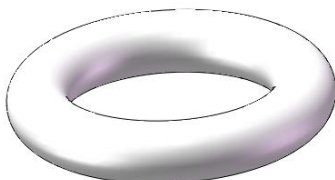
Part No.	Part Name	Quantity	
2	Filter supporting base	1	
3	Outlet connection nozzle	1	
4	Temperature control jacket	1	
5	Large O-ring	3	
6	Small O-ring	2	

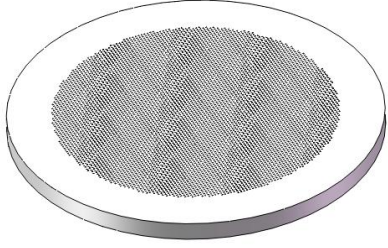
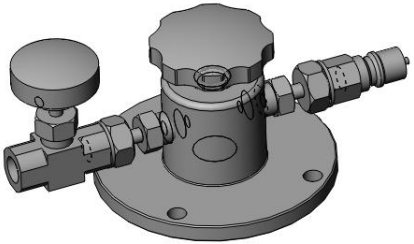
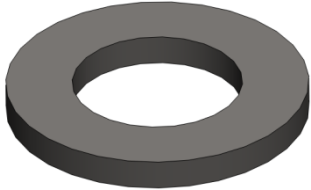
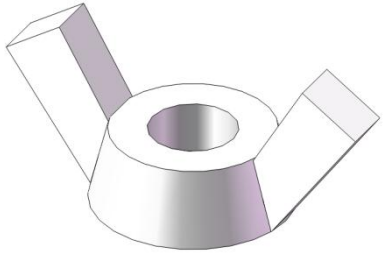
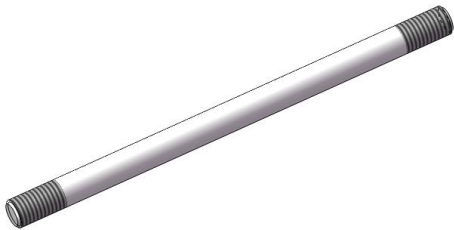
Part No.	Part Name	Quantity	
7	Stainless steel micron pore support plate	1	
8	Upper cover of the extruder	1	
9	Flat gasket	4	
10	Butterfly nut	4	
11	Pull rod	4	

Part No.	Part Name	Quantity	
12	High-pressure nitrogen connection	1	

The following items are optional parts.

- a. Nano membrane
- b. High-pressure homogenizer or high-pressure pump

5. Assembly Procedure

The table below describes the assembly steps of 100ml Genizer™ jacketed temperature-control extruder. Refer to the Parts List in the assembly.

Step 1

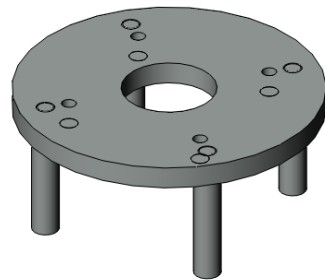

Place the bracket base (1) onto a proper platform. Remove unnecessary devices in the operation area.

Step 2

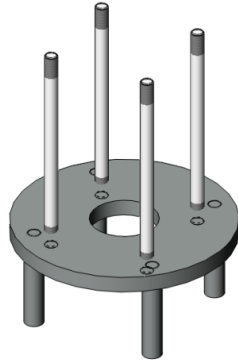

Mount four pull rods (11) on the bracket base (1).

Step 3



Tighten the screws of the filter supporting base (2) and the outlet connection nozzle (3) with a spanner.

Step 4

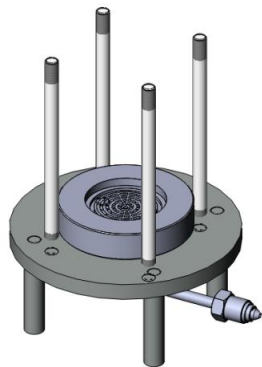

Place the mounted units in step 3 onto the bracket base (1).

Step 5

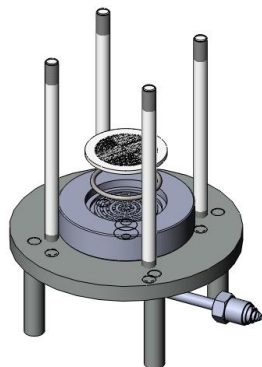

Mount the large O-ring (5) and stainless steel micron pore support plate (7) on the filter supporting base in order.

Attention: the pore of the

stainless steel micron pore support plate (7) should face up when mounted.

Step 6

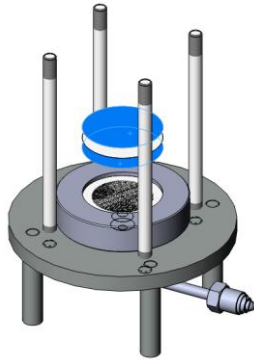

Place the nano-membrane of specific size on the stainless steel micron pore support plate (7) carefully.

Attention: the nano-membrane must be placed flatly without any wrinkle or bubble. Wet and then flat it to make it fixed.

Step 7

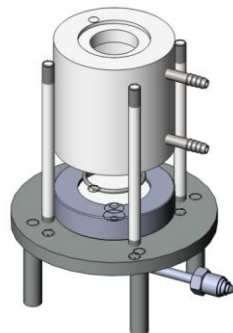

Place the large O-ring (5) and jacket (4) on the filter supporting base (2) in order.

Step 9

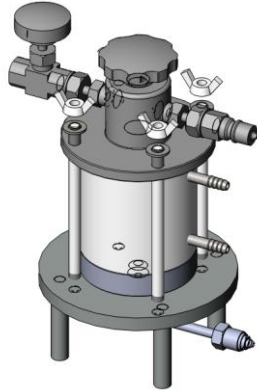

Mount the flat gasket (9) and butterfly nut (10) onto the pull rod (11) in order.

Step 10

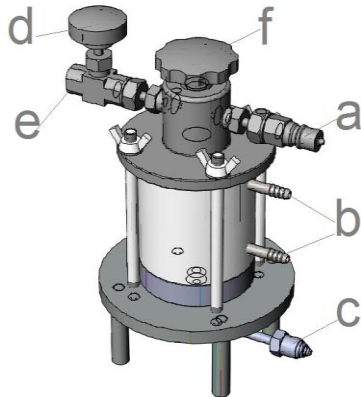

Nozzle a: connected to the female of high-pressure nitrogen connection (12)

Joint b: connected to the water bath tubing

Joint c: connected to the product tubing

d: deflation valve

Joint e: gas vent

f: feed port

6. General Operating Steps

6.1 Operation Steps

Follow step 10 to connect the tubing. Switch on the deflation valve (d) on

the upper cover (8) of the extruder anticlockwise. Open the feed port (f) and fill in no more than 100ml material. Connect the other end of the high-pressure nitrogen connection (12) to the nitrogen cylinder with regulator. The waterbath connected to joint (b) on the temperature-control jacket will heat the material up to a specified temperature (Put the material in the waterbath if the preheating temperature is in the range of 50- 80°C. Make sure the water line is above the level of the filter supporting base (2)). Adjust the air pressure with the valve on the nitrogen cylinder to establish the pressure in the extruder. Materials extruded by the nitrogen will then be pushed through the nanopores in the nano membrane to the product tubing (c).



Attention: Close the nitrogen after the operation.

6.2 General Cleaning

In general, please follow the steps below to clean the extruder. Some special compounds should be cleaned specifically.

1. The extruder should be cleaned immediately after operation. Disassemble the extruder according to Parts List.



Instruction Manual

High-pressure Jacketed Extruder

2. We recommend non-phosphate detergents. Keep the water fairly warm and use a brush to clean parts difficult to reach. Clean the extruder with warm soapy water and then wash with plenty of tap water.

3. Rinse the components under tap water and then wash with distilled water a few more times.

4. All stainless steel parts should be cleaned with 70% ethanol solution. The O-rings must be removed before the wash, or they may get corroded in organic solvents.

7. Trouble Shootings

7.1 Please reassemble the extruder if there is any gas or material leakage. Check if all O-rings are correctly mounted, and if the butterfly nut or any fastener is missed.

7.2 The following factors may make the extruding slow:

7.2.1 The extruding gets incredibly slow if a nano-membrane with small pore size is used to filter materials with large-particle size. It is recommended that the material be filtered first through nano-membrane with large-pore size before the application of the small-pore one.

7.2.2 The filtration resistance becomes excessively high when the material gets condensate at the current operation temperature. Please change the temperature.

7.2.3 The filtration capacity decreases dramatically when the nano-membrance is blocked. Replace the nano-membrance in this case.

7.2.4 The material mixtures are not homogeneous can cause the blockage of the membrane. Please optimize the pretreatment.

7.3 Check if the connection between the temperature-control jacket and waterbath is correct and whether the circulation is smooth when the temperature-control jacket remains unheated.



Instruction Manual

High-pressure Jacketed Extruder

Genizer Liposome Extruder System

Solution for liposome and nanoparticle extrusion

Catalog No.	Thermo-control	Power mode		Micron-pore plate	Maximum pressure	Dimension L×W×H(cm)/Weight(kg)	Nano membrane
		Air	Online				
HandExtruder-1ml-RT HandExtruder-1ml	Optional	/	/	/	150 psi	23×17×33/2 (jacketed)	
						23×17×13/2	
Test Scale GExtruder-10ml GExtruder-5ml/min	Optional	Y	Y	Y	3,000 psi	23×13×25/4 (jacketed)	30 nm
						10×10×8/1	50 nm
GExtruder-100ml GExtruder-50ml/min	Optional	Y	Y	Y	3,000 psi	23×20×32/7 (jacketed)	80 nm
						12.5×12.5×9/2	
Pilot Scale GExtruder-800ml GExtruder-400ml/min	Optional	Y	Y	Y	3,000 psi	25×25×37/20 (jacketed)	100 nm
						18×18×10/5	
GExtruder-3000ml GExtruder-1500ml/min	Optional	Y	Y	Y	3,000 psi	30×25×55/45 (jacketed)	200 nm
						30×25×25/21	400 nm
Production Scale GExtruder-10000ml GExtruder-5000ml/min	Optional	Y	Y	Y	3,000 psi	45×40×65/130 (jacketed)	800 nm
						45×40×30/90	
Customize Scale GExtruder 0-50000ml or Multi-Extruder	Optional	Y	Y	Y	up to 6,000 psi	TBD (jacketed) TBD	

Notice: The dimension, structure and parameter should be subject to the final product.